

## Features

- 280W Peak Pulse Power Per Line(8/20us)
- 24V Working Peak Reverse Voltage
- Maximum Reverse Peak Pulse Current:6A
- ESD per IEC 61000-4-2(Contact):25KV
- ESD per IEC 61000-4-2(Air):30KV
- Clamping Voltage @IPP=1A:34V
- Junction Capacitance:20PF
- Package:DFN1006-2L(0402)
- Polarity: Bidirectional

## Mechanical Characteristics

- Mechanical Characteristics
- Lead Finish: NiPdAu
- Case Material: “ Green ” Molding Compound.
- UL Flammability Classification Rating 94V-0
- Moisture Sensitivity: Level 3 per J-STD-020
- Terminal Connections: See Diagram Below
- Marking Information: See Below

## Schematic And Configuration

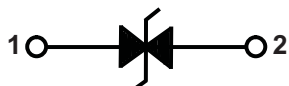

## Ordering Information

| Part Number    | Packaging   | Reel Size |
|----------------|-------------|-----------|
| TEVB20R0V24B1X | Tape & Reel | 7inch     |

## Absolute Maximum Ratings (Ta=25 °C, RH=45%-75%, unless otherwise noted)

| Parameter                   | Symbol | Value    | Unit |
|-----------------------------|--------|----------|------|
| Operating Temperature Range | Tj     | -55~+125 |      |
| Storage Temperature Range   | Tstg   | -55~+150 |      |

## Electrical Characteristics (Ta=25 °C)

| Parameter               | Symbol | Min  | Type | Max | Unit | Test Condition         |
|-------------------------|--------|------|------|-----|------|------------------------|
| Reverse Working Voltage | Vrwm   |      |      | 24  | V    |                        |
| Breakdown Voltage       | Vbr    | 29.2 |      |     | V    | It=1mA                 |
| Reverse Leakage Current | Ir     |      |      | 0.1 | uA   | Vrwm=24V               |
| Clamping Voltage        | Vc     |      | 34   | 36  | V    | Ipp=1A(8 × 20us pulse) |
| Juntion Capacitance     | Cj     |      | 16   | 20  | pF   | Vr=0V,f=1MHz           |

**Typical Performance Characteristics** (Ta=25 , unless otherwise noted)

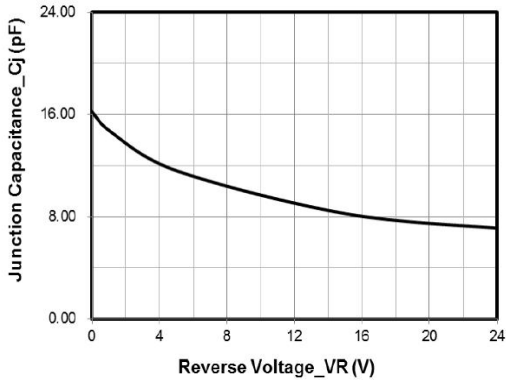

**Junction Capacitance vs. Reverse Voltage**

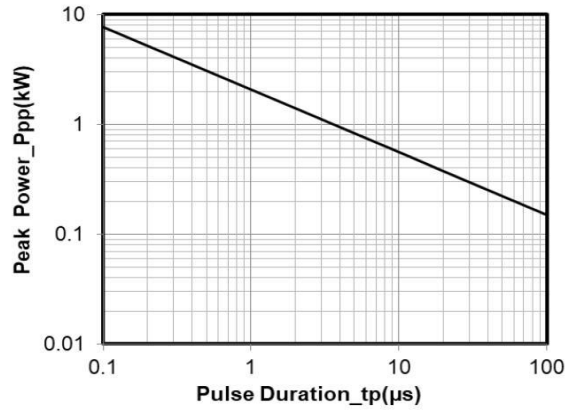

**Peak Pulse Power vs. Pulse Time**

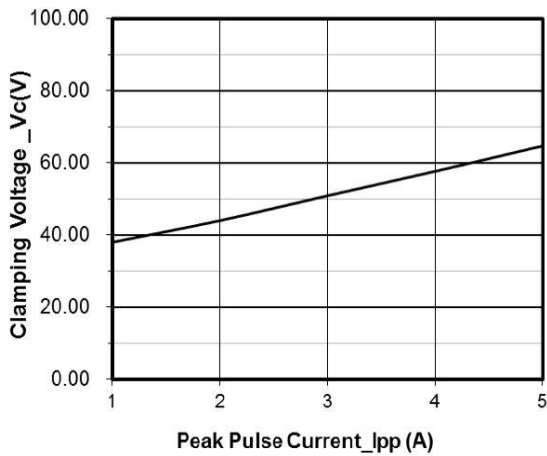

**Clamping Voltage vs. Peak Pulse Current**

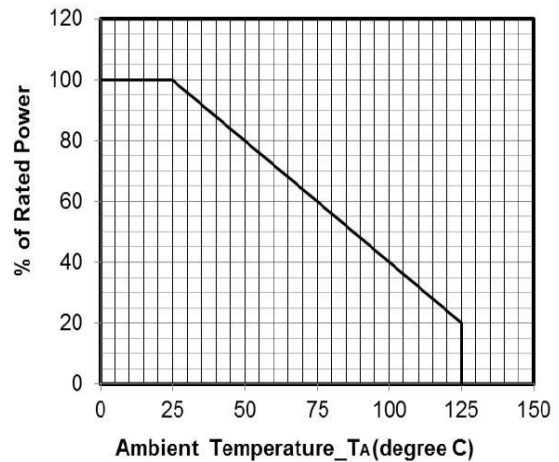

**Power Derating Curve**

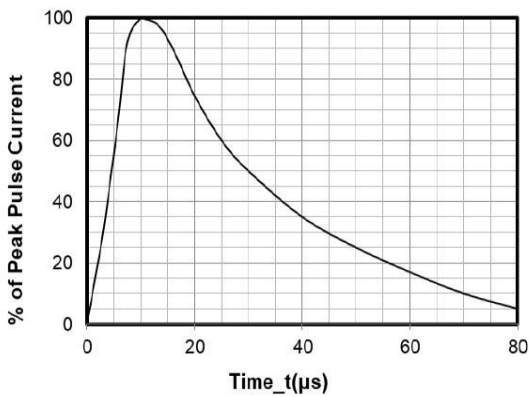

**8 X 20μs Pulse Waveform**

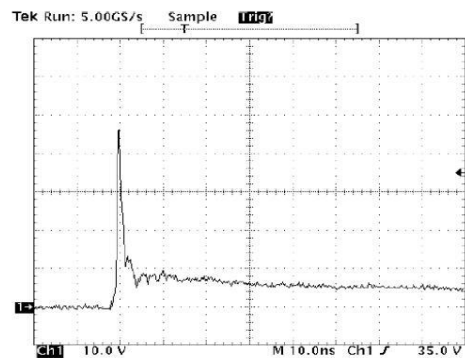

**Note: Data is taken with a 10x attenuator**

**ESD Clamping Voltage**

**8 kV Contact per IEC61000-4-2**

**Soldering Parameters**

| Reflow Condition  |                                   | Pb-Free Assembly<br>(see as bellow) |
|---|-----------------------------------|-------------------------------------|
| Pre Heat  | -Temperature Min ( $T_{s(min)}$ ) | +150°C                              |
|   | -Temperature Max( $T_{s(max)}$ )  | +200°C                              |
|   | -Time (Min to Max) ( $t_s$ )      | 60-180 secs.                        |
| Average ramp up rate (Liquid us Temp ( $T_L$ ) to peak) |                                   | 3°C/sec. Max                        |
| $T_{s(max)}$ to $T_L$ - Ramp-up Rate                    |                                   | 3°C/sec. Max                        |
| Reflow  | -Temperature( $T_L$ ) (Liquid us) | +217°C                              |
|   | -Temperature( $t_L$ )             | 60-150 secs.                        |
| Peak Temp ( $T_P$ )                                     |                                   | +260(+0/-5)°C                       |
| Time within 5°C of actual Peak Temp ( $t_p$ )           |                                   | 30 secs. Max                        |
| Ramp-down Rate  |                                   | 6°C/sec. Max                        |
| Time 25°C to Peak Temp ( $T_P$ )                        |                                   | 8 min. Max                          |
| Do not exceed   |                                   | +260°C                              |

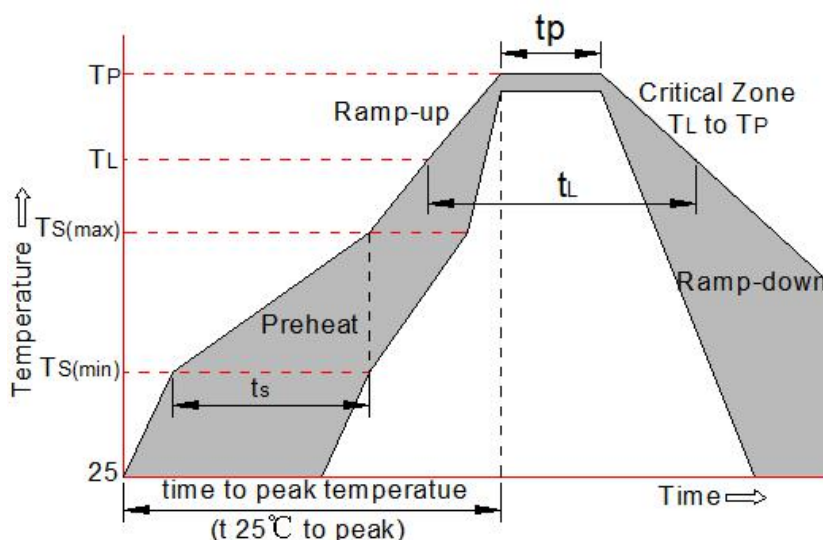

**Package Mechanical Data**

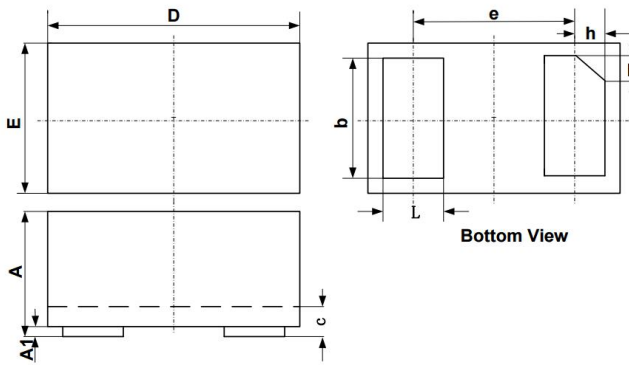

| SYM | DIMENSIONS  |      |      |           |       |       |
|-----|-------------|------|------|-----------|-------|-------|
|     | MILLIMETERS |      |      | INCHES    |       |       |
|     | MIN         | NOM  | MAX  | MIN       | NOM   | MAX   |
| A   | 0.45        | 0.50 | 0.55 | 0.018     | 0.020 | 0.022 |
| A1  | 0.00        | 0.02 | 0.05 | 0.000     | 0.001 | 0.002 |
| b   | 0.45        | 0.50 | 0.55 | 0.018     | 0.020 | 0.022 |
| c   | 0.12        | 0.15 | 0.18 | 0.005     | 0.006 | 0.007 |
| D   | 0.95        | 1.00 | 1.05 | 0.037     | 0.039 | 0.041 |
| e   | 0.65 BSC    |      |      | 0.026 BSC |       |       |
| E   | 0.55        | 0.60 | 0.65 | 0.022     | 0.024 | 0.026 |
| L   | 0.20        | 0.25 | 0.30 | 0.008     | 0.010 | 0.012 |
| h   | 0.07        | 0.12 | 0.17 | 0.003     | 0.005 | 0.007 |

**Suggested Land Pattern**

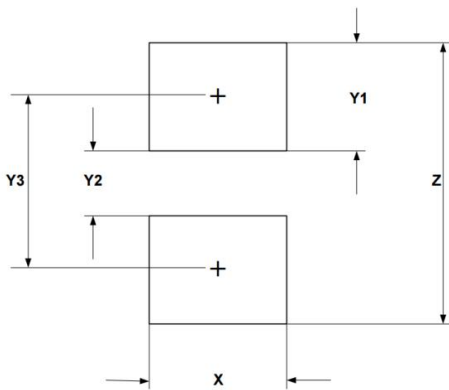

| SYM | DIMENSIONS  |        |
|-----|-------------|--------|
|     | MILLIMETERS | INCHES |
| X   | 0.60        | 0.024  |
| Y1  | 0.50        | 0.020  |
| Y2  | 0.30        | 0.012  |
| Y3  | 0.80        | 0.032  |
| Z   | 1.30        | 0.052  |